

REVISIONS

LETTER	DESCRIPTION	DWG BY	DATE
A	REDRAWN , UPDATED NOTES AND DIMENSIONS	JOW3	10-17-16
B	UPDATED NOTES	JOW3	2-3-17
C	UPDATED LABEL	JOW3	6-16-17

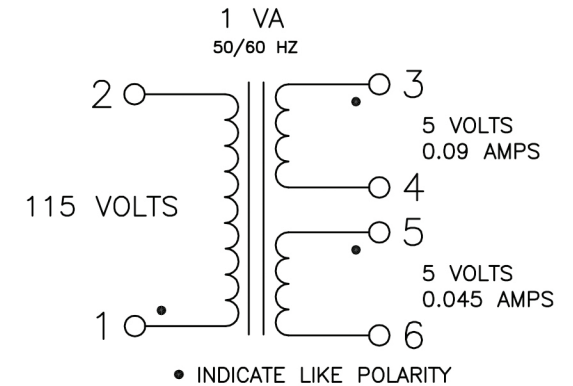
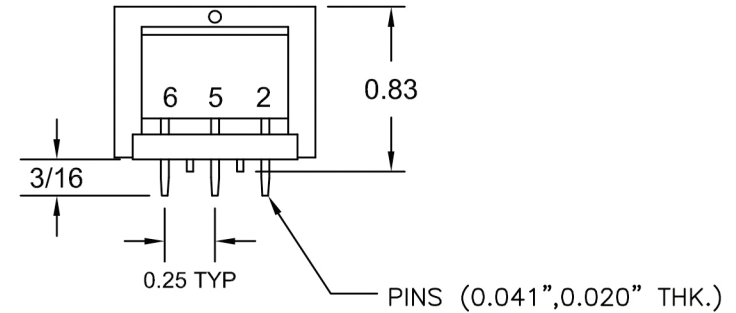
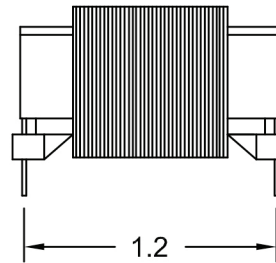
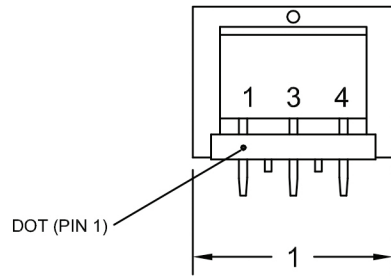
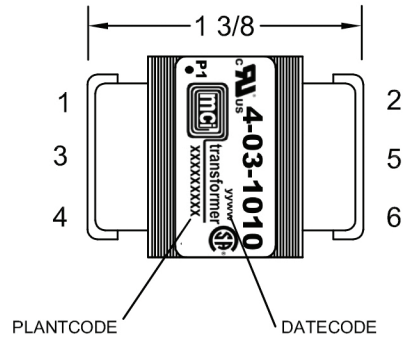

NOTES:

- 1) UL RECOGNIZED COMPONENT: FILE # E86403
- 2) CSA CERTIFIED COMPONENT: FILE # LR80864
- 3) 1500 VRMS HIPOT BETWEEN PRIMARY AND (SECONDARY + CORE).
500 VOLTS BETWEEN SECONDARY AND CORE.
- 4) WEIGHT: 2.5 OZ.
- 5) RoHS AND REACH COMPLIANT
- 6) ALL DIMENSIONS ARE IN INCHES.

MCI					<small>NORTH BABYLON N.Y.</small>
CUSTOMER		MCI			
TITLE		VERTICAL PC TRANSFORMER			
DRAWN BY	APPRVD BY	SCALE	DATE	DRAWING NUMBER	
SMS	JOW	NONE	10-1-14	4-03-1010	