

REVISIONS

LETTER	DESCRIPTION	DWG BY	DATE
A	REDRAWN UPDATED NOTES AND DIMENSIONS	JOW3	11-2-16
B	UPDATED NOTES	JOW3	2-3-17
C	UPDATED LABEL	JOW3	6-19-17

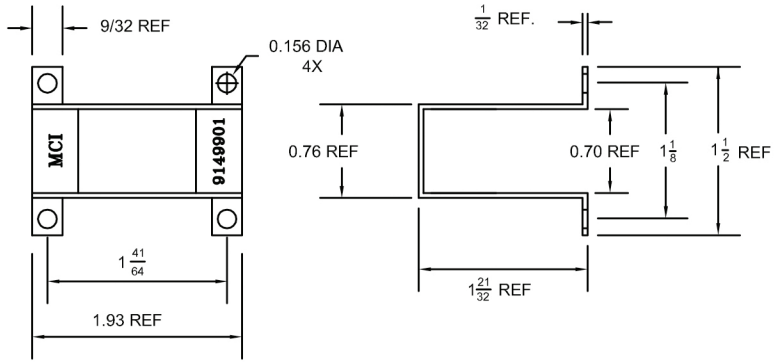

OPTIONAL MOUNTING BRACKET: PART #9-14-9901

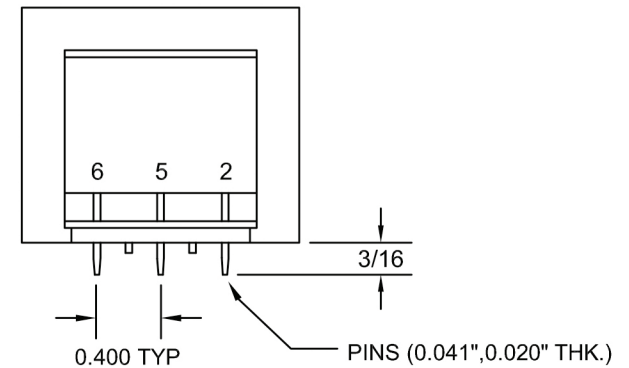
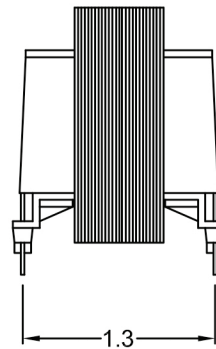
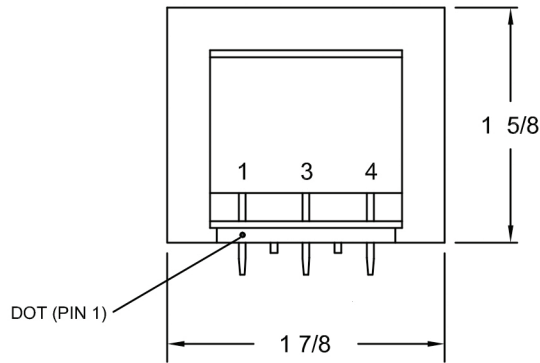
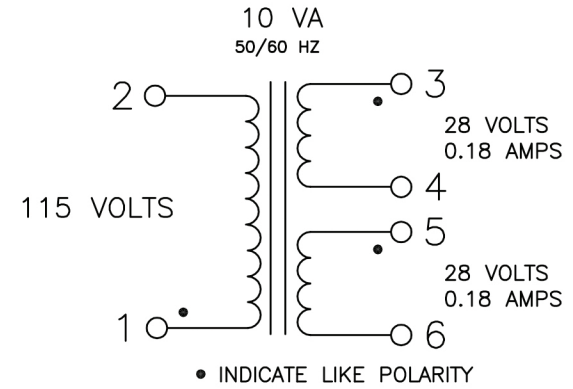
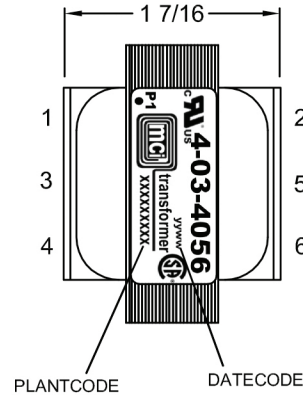

NOTES:

- 1) UL RECOGNIZED COMPONENT: FILE # E86403
- 2) CSA CERTIFIED COMPONENT: FILE # LR80864
- 3) 1500 VRMS HIPOT BETWEEN PRIMARY AND (SECONDARY + CORE).
500 VOLTS BETWEEN SECONDARY AND CORE.
- 4) WEIGHT: 0.56 LBS
- 5) RoHS AND REACH COMPLIANT
- 6) ALL DIMENSIONS ARE IN INCHES.

MCI				<small>NORTH BABYLON N.Y.</small>
CUSTOMER MCI				
TITLE VERTICAL PC TRANSFORMER				
DRAWN BY SMS	APPRVD BY JOW	SCALE NONE	DATE 10-10-14	DRAWING NUMBER 4-03-4056