

REVISIONS

LETTER	DESCRIPTION	DWG BY	DATE
A	REDRAWN AND UPDATED NOTES	JOW3	11-11-16
B	UPDATED NOTES	JOW3	2-6-17
C	UPDATED LABEL	JOW3	6-27-17

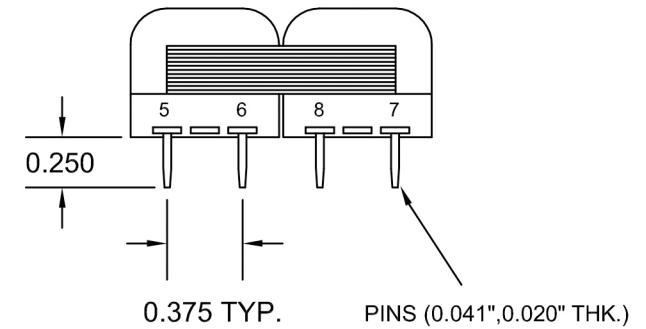
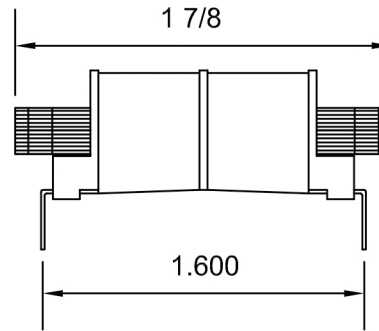
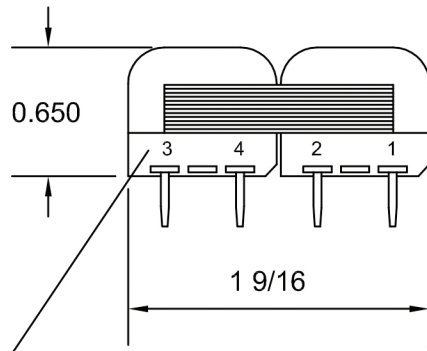
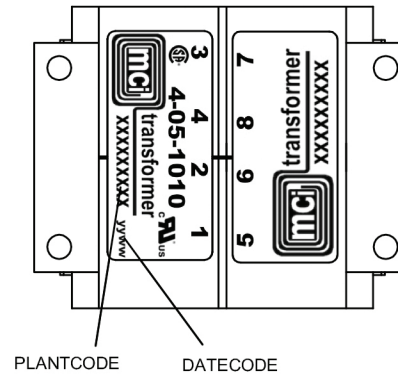
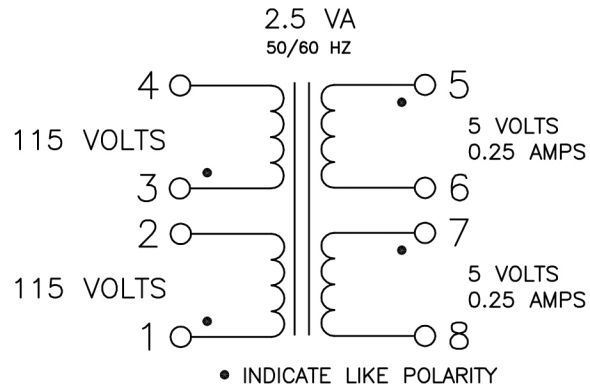

PIN NUMBERS ARE FOR REFERENCE ONLY

NOTES:

- 1) UL INSULATION SYSTEM CLASS F (155°C): FILE # E86543
- 2) UL RECOGNIZED COMPONENT: FILE # E86403
- 3) CSA CERTIFIED COMPONENT: FILE # LR80864
- 4) 1500 VRMS HIPOT BETWEEN PRIMARY AND (SECONDARY + CORE).
500 VOLTS BETWEEN SECONDARY AND CORE.
- 5) WEIGHT: 5 OZ
- 6) RoHS AND REACH COMPLIANT
- 7) ALL DIMENSIONS ARE IN INCHES.

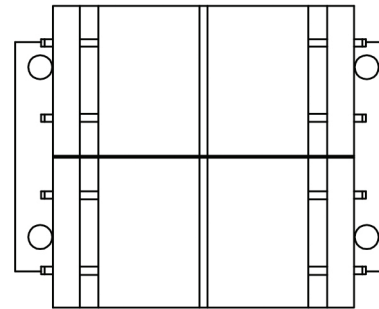

MCI					<small>NORTH BABYLON N.Y.</small>
CUSTOMER		MCI			
TITLE					LOW PROFILE PC TRANSFORMER
DRAWN BY	APPRVD BY	SCALE	DATE	DRAWING NUMBER	
SMS	JOW	NONE	10-15-14	4-05-1010	