

REVISIONS

LETTER	DESCRIPTION	DWG BY	DATE
A	UPDATED DRAWING AND NOTES	SMS	10-16-14
B	REDRAWN AND UPDATED NOTES	JOW3	11-14-16
C	UPDATED NOTES	JOW3	2-6-17
D	UPDATED LABEL	JOW3	6-26-17

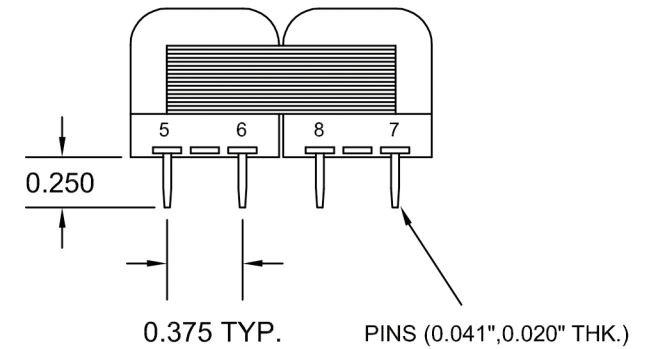
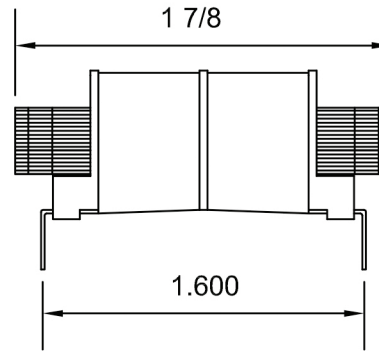
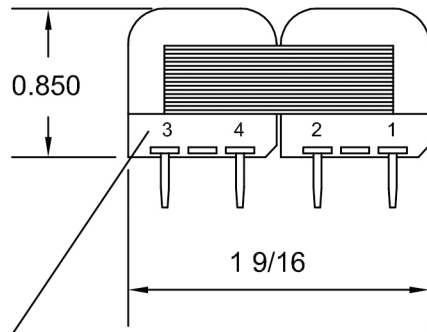
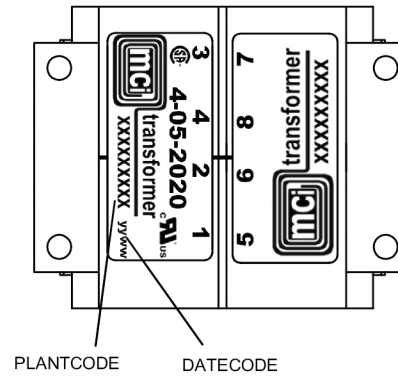
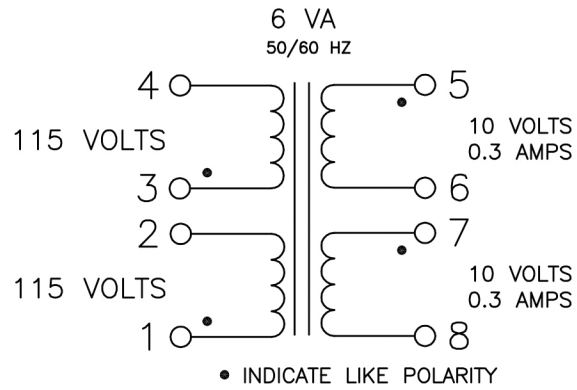

PIN NUMBERS ARE FOR REFERENCE ONLY

NOTES:

- 1) UL INSULATION SYSTEM CLASS F (155°C): FILE # E86543
- 2) UL RECOGNIZED COMPONENT: FILE # E86403
- 3) CSA CERTIFIED COMPONENT: FILE # LR80864
- 4) 1500 VRMS HIPOT BETWEEN PRIMARY AND (SECONDARY + CORE).
500 VOLTS BETWEEN SECONDARY AND CORE.
- 5) WEIGHT: 7 OZ
- 6) RoHS AND REACH COMPLIANT
- 7) ALL DIMENSIONS ARE IN INCHES.

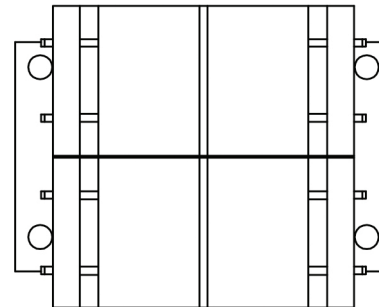

MCI				
<i>NORTH BABYLON N.Y.</i>				
CUSTOMER		MCI		
TITLE				
LOW PROFILE PC TRANSFORMER				
DRAWN BY	APPRVD BY	SCALE	DATE	DRAWING NUMBER
SMS	JOW	NONE	9-5-95	4-05-2020