

REVISIONS

LETTER	DESCRIPTION	DWG BY	DATE
A	UPDATED DRAWING AND NOTES	SMS	10-17-14
B	REDRAWN AND UPDATED NOTES	JOW3	11-15-16
C	UPDATED NOTES	JOW3	2-6-17
D	UPDATED DRAWING AND LABEL	JOW3	6-23-17

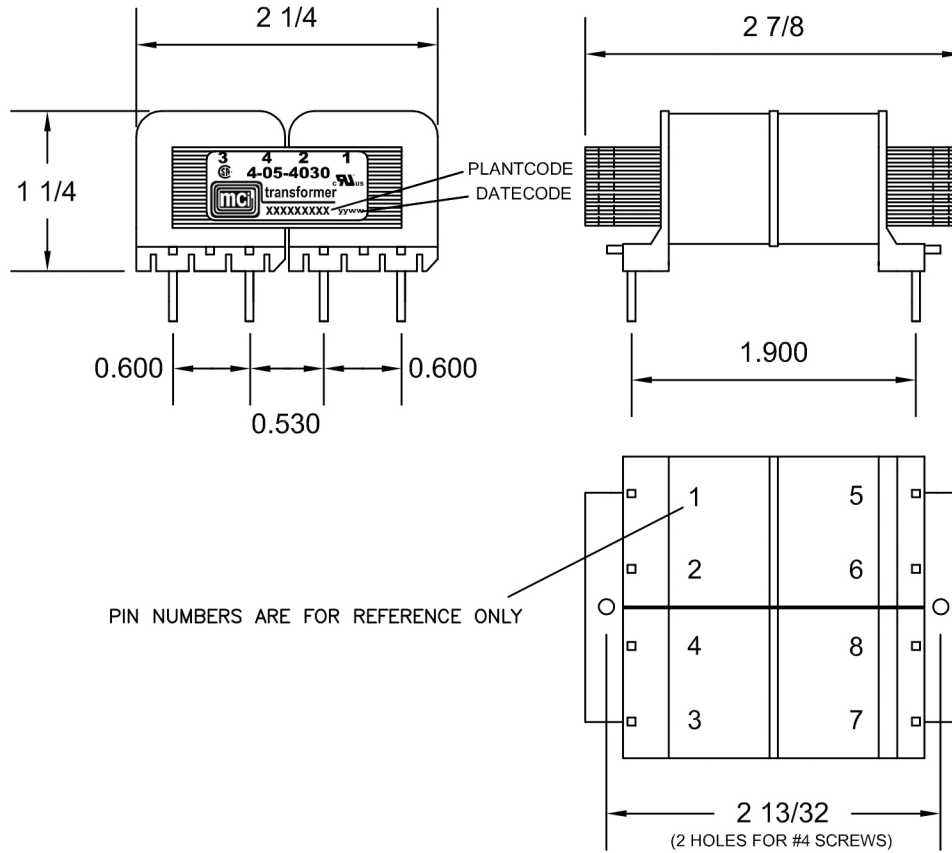

PIN NUMBERS ARE FOR REFERENCE ONLY

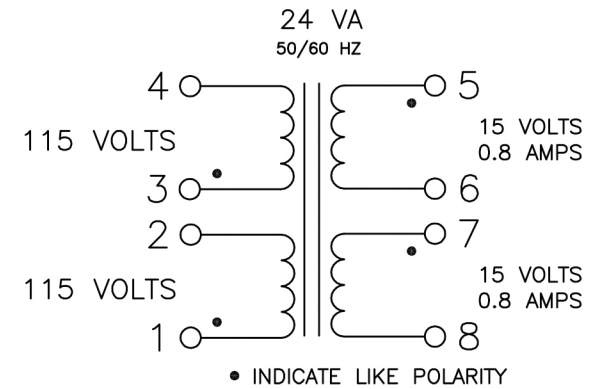
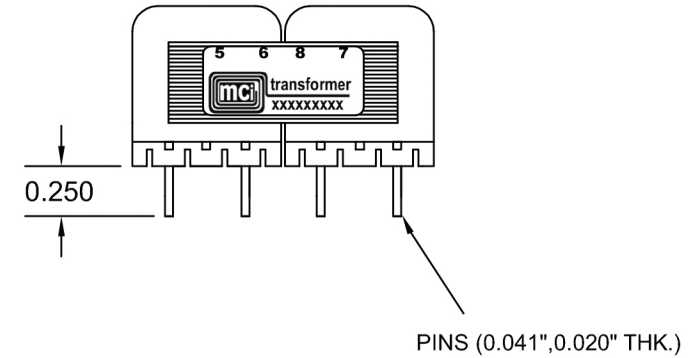

NOTES:

- 1) UL INSULATION SYSTEM CLASS F (155°C): FILE # E86543
- 2) UL RECOGNIZED COMPONENT: FILE # E86403
- 3) CSA CERTIFIED COMPONENT: FILE # LR80864
- 4) 1500 VRMS HIPOT BETWEEN PRIMARY AND (SECONDARY + CORE).
500 VOLTS BETWEEN SECONDARY AND CORE.
- 5) WEIGHT: 0.94 LB
- 6) RoHS AND REACH COMPLIANT
- 7) ALL DIMENSIONS ARE IN INCHES.

MCI					<small>NORTH BABYLON N.Y.</small>
CUSTOMER					MCI
TITLE					LOW PROFILE PC TRANSFORMER
DRAWN BY	APPRVD BY	SCALE	DATE	DRAWING NUMBER	
SMS	JOW	NONE	2-2-13	4-05-4030	