

REVISIONS

LETTER	DESCRIPTION	DWG BY	DATE
A	REDRAWN AND UPDATED NOTES	JOW3	11-16-16
B	UPDATED NOTES	JOW3	2-7-17
C	UPDATED LABEL	JOW3	5-26-17

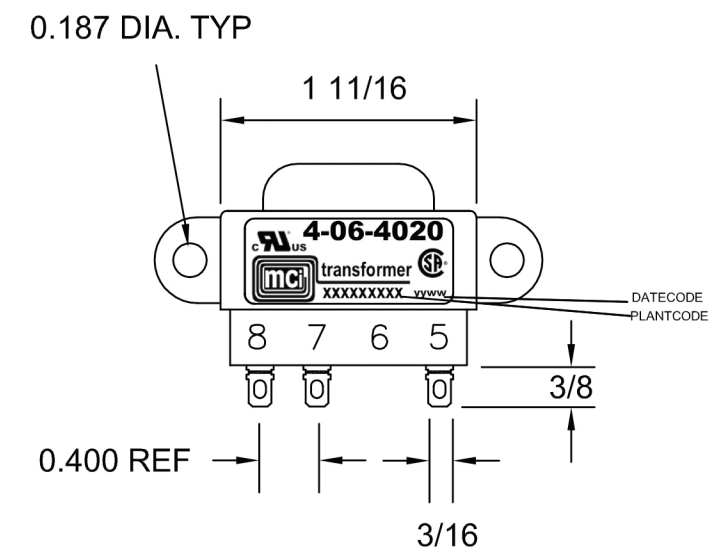
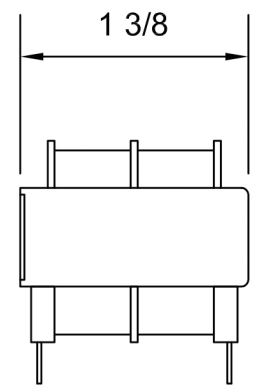
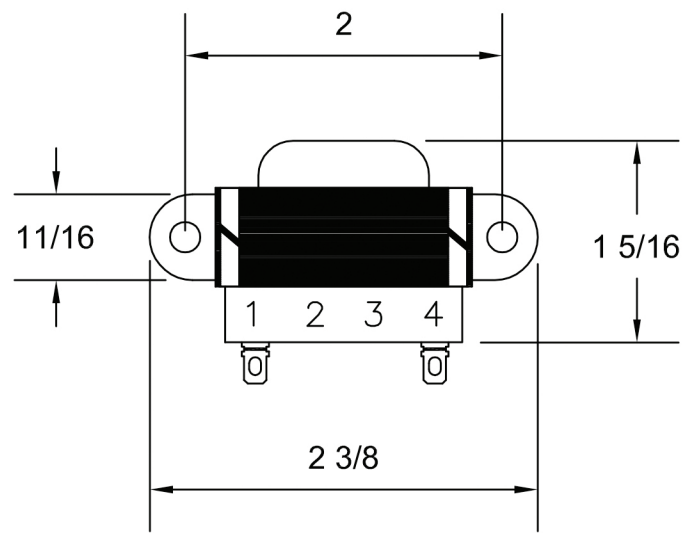

NOTES:

- 1) UL INSULATION SYSTEM E86543-CLASS F 155°C.
- 2) UL RECOGNIZED COMPONENT: FILE # E86403
- 3) CSA CERTIFIED COMPONENT: FILE # LR80864
- 4) 2500 VRMS HIPOT BETWEEN PRIMARY AND (SECONDARY + CORE).
500 VOLTS BETWEEN SECONDARY AND CORE.
- 5) WEIGHT: 0.44 LBS.
- 6) RoHS AND REACH COMPLIANT
- 7) ALL DIMENSIONS ARE IN INCHES.

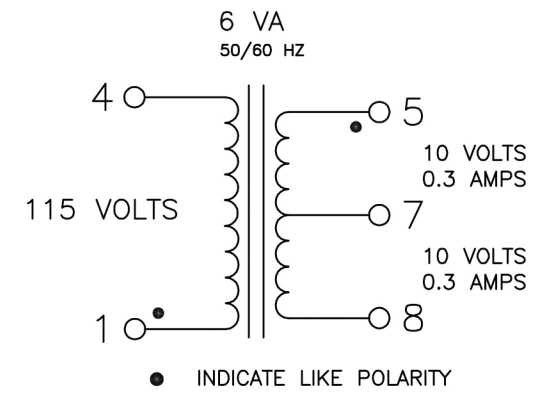

MCI		<small>NORTH BABYLON N.Y.</small>	
CUSTOMER		MCI	
TITLE			
QUICK CONNECT POWER TRANSFORMER			
DRAWN BY	APPRVD BY	SCALE	DATE
SMS	JOW	NONE	10-20-14
DRAWING NUMBER			4-06-4020