

REVISIONS

LETTER	DESCRIPTION	DWG BY	DATE
A	UPDATED DRAWING AND NOTES	SMS	10-24-14
B	REDRAWN AND UPDATED NOTES	JOW3	11-16-16
C	UPDATED NOTES	JOW3	2-7-17
D	UPDATED LABEL	JOW3	5-30-17

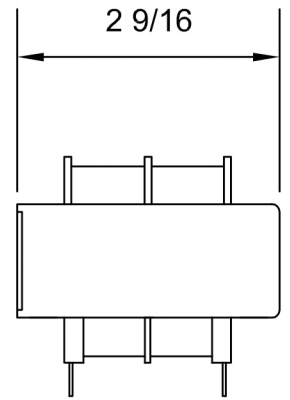

0.187 DIA. TYP

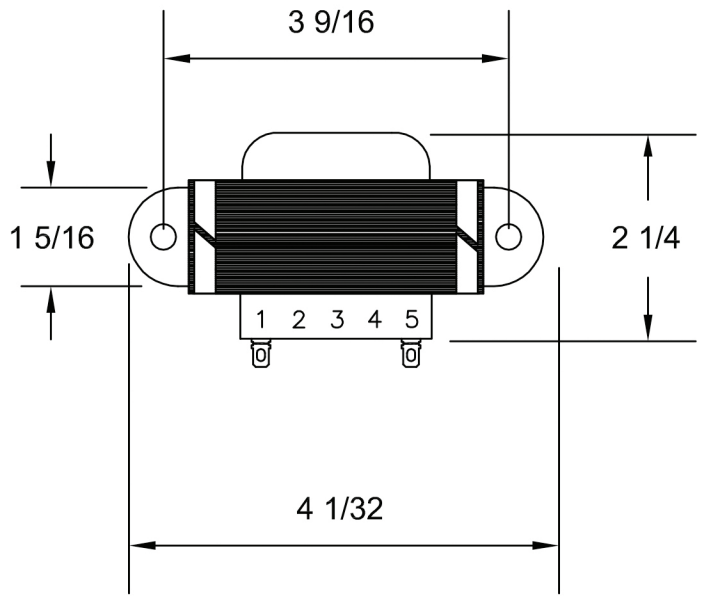
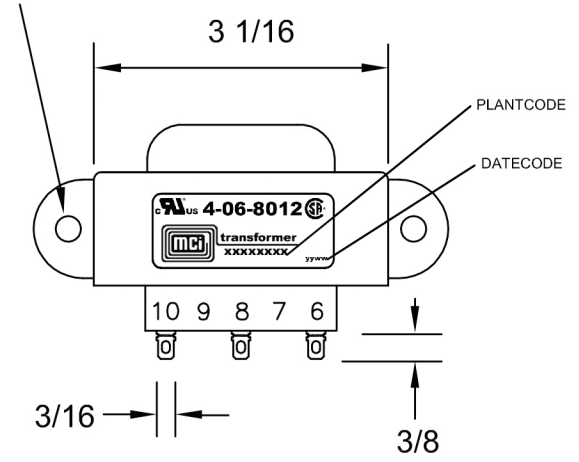

100 VA
50/60 HZ

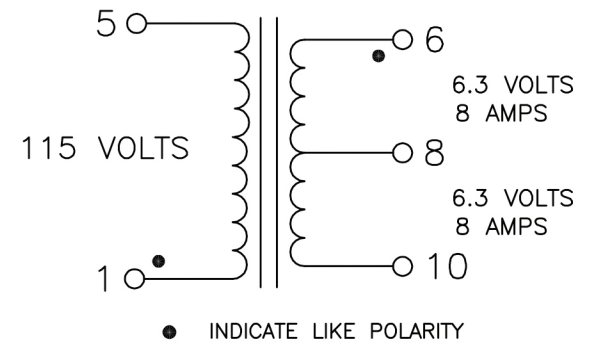

NOTES:

- 1) UL INSULATION SYSTEM E86543-CLASS F 155°C.
- 2) UL RECOGNIZED COMPONENT: FILE # E86403
- 3) CSA CERTIFIED COMPONENT: FILE # LR80864
- 4) 2500 VRMS HIPOT BETWEEN PRIMARY AND (SECONDARY + CORE).
500 VOLTS BETWEEN SECONDARY AND CORE.
- 5) WEIGHT: 2.75 LBS.
- 6) RoHS AND REACH COMPLIANT
- 7) ALL DIMENSIONS ARE IN INCHES.

MCI					<i>NORTH BABYLON N.Y.</i>
CUSTOMER		MCI			
TITLE					QUICK CONNECT POWER TRANSFORMER
DRAWN BY	APPRVD BY	SCALE	DATE	DRAWING NUMBER	
SMS	JOW	NONE	6-14-06	4-06-8012	