

REVISIONS

LETTER	DESCRIPTION	DWG BY	DATE
A	REDRAWN AND UPDATED NOTES	JOW3	11-18-16

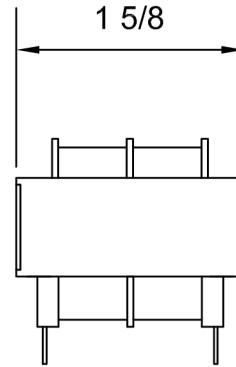

0.187 DIA. TYP

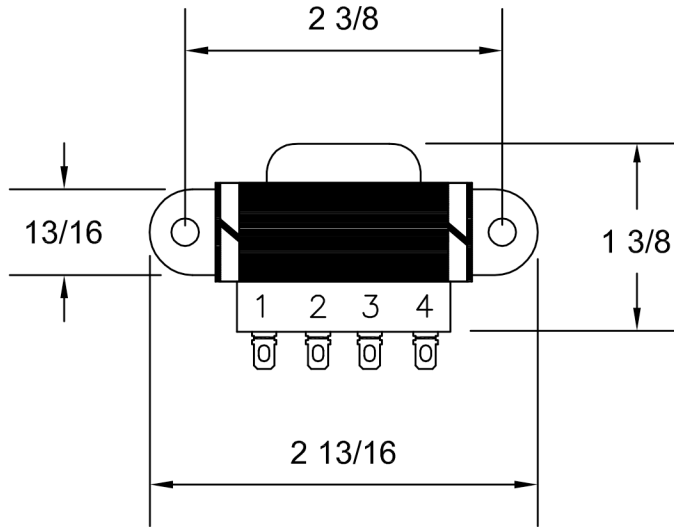
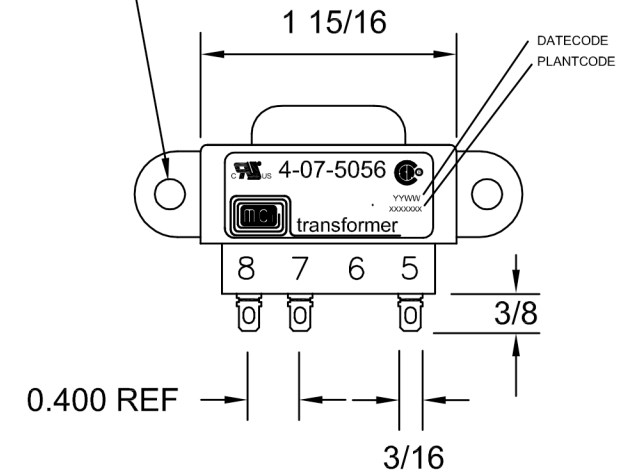

NOTES:

- 1) UL INSULATION SYSTEM E86543-CLASS F 155°C.
- 2) UL RECOGNIZED COMPONENT: FILE # E86403
- 3) CSA APPROVED COMPONENT: FILE # LR80864
- 4) 2500 VRMS HIPOT BETWEEN PRIMARY AND (SECONDARY + CORE).
500 VOLTS BETWEEN SECONDARY AND CORE.
- 5) WEIGHT: 0.7 LBS.
- 6) RoHS AND REACH COMPLIANT
- 7) ALL DIMENSIONS ARE IN INCHES.

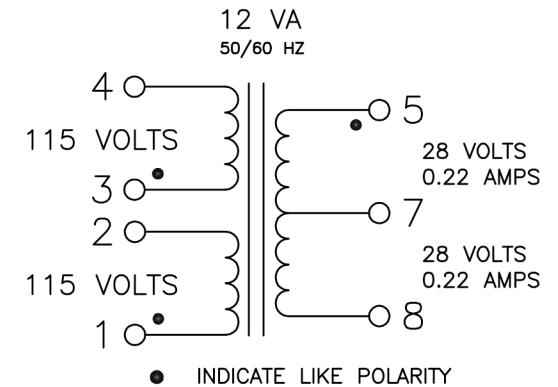

MCI				<i>NORTH BABYLON N.Y.</i>
CUSTOMER		MCI		
TITLE				
QUICK CONNECT POWER TRANSFORMER				
DRAWN BY	APPRVD BY	SCALE	DATE	DRAWING NUMBER
SMS	JOW	NONE	10-22-14	4-07-5056