

REVISIONS

LETTER	DESCRIPTION	DWG BY	DATE

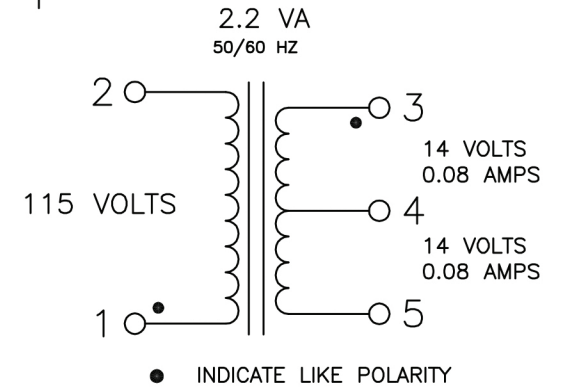
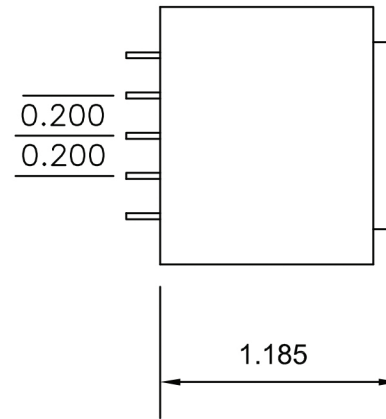
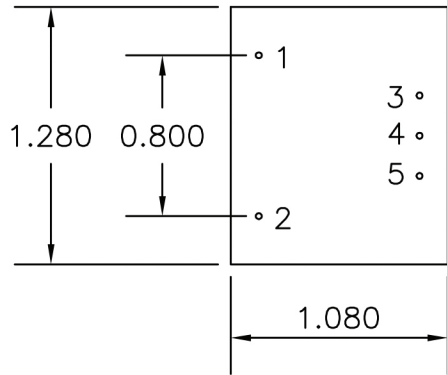
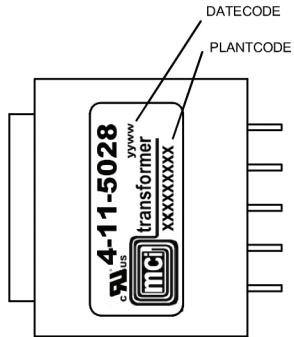
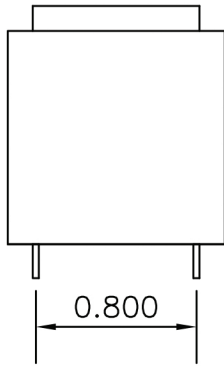

NOTES:

- 1) UL RECOGNIZED COMPONENT: FILE # E86403
- 2) 3750 VRMS HIPOT BETWEEN PRIMARY AND SECONDARY.
- 3) WEIGHT: 0.25 LBS.
- 4) RoHS AND REACH COMPLIANT
- 5) ALL DIMENSIONS ARE IN INCHES.

MCI		<small>NORTH BABYLON N.Y.</small>	
CUSTOMER		MCI	
TITLE			
HORIZONTAL PC TRANSFORMER			
DRAWN BY	APPRVD BY	SCALE	DATE
JOW3	JOW	NONE	11-22-16
DRAWING NUMBER			4-11-5028