

REVISIONS

LETTER	DESCRIPTION	DWG BY	DATE

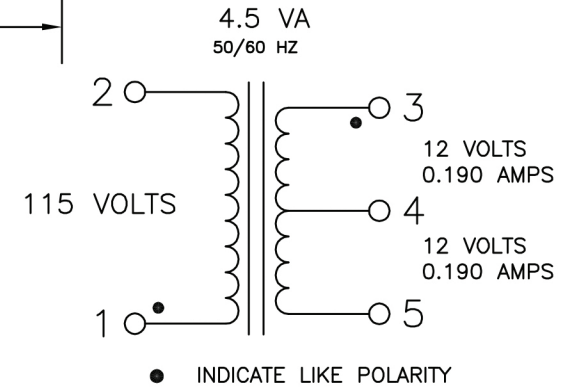
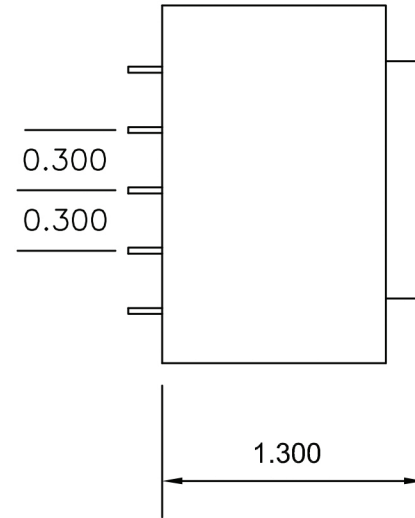
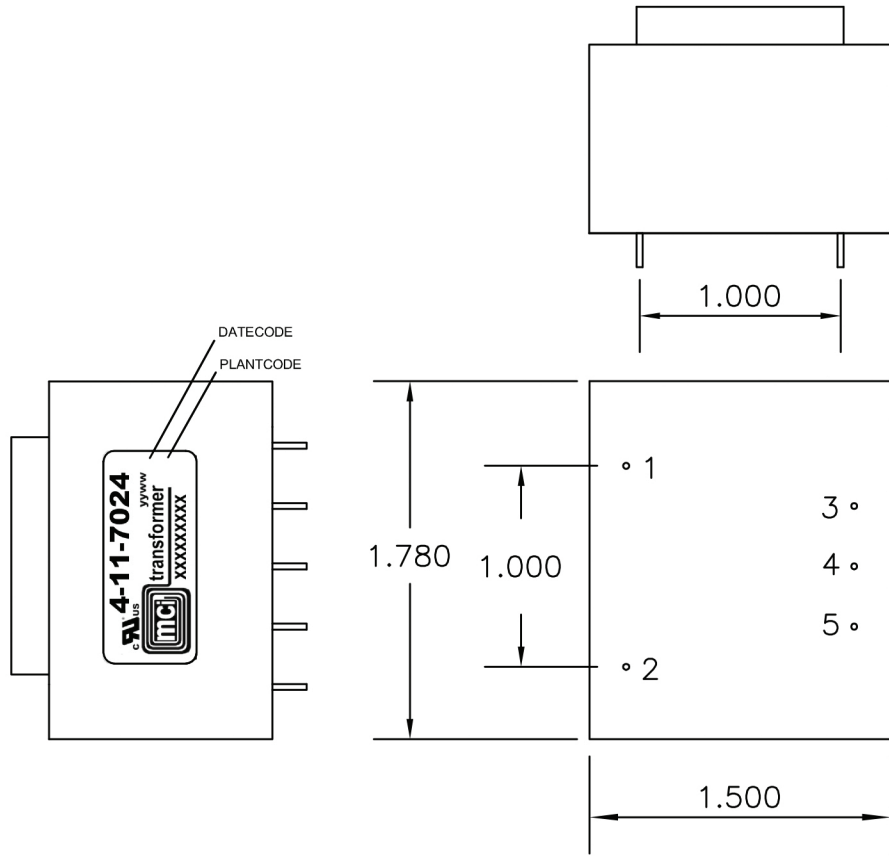

NOTES:

- 1) UL RECOGNIZED COMPONENT: FILE # E86403
- 2) 3750 VRMS HIPOT BETWEEN PRIMARY AND SECONDARY.
- 3) WEIGHT: 0.44 LBS.
- 4) RoHS AND REACH COMPLIANT
- 5) ALL DIMENSIONS ARE IN INCHES.

MCI					<i>NORTH BABYLON N.Y.</i>
CUSTOMER					MCI
TITLE					HORIZONTAL PC TRANSFORMER
DRAWN BY	APPRVD BY	SCALE	DATE	DRAWING NUMBER	
JOW3	JOW	NONE	12-2-16	4-11-7024	