

# REVISIONS

LETTER	DESCRIPTION	DWG BY	DATE

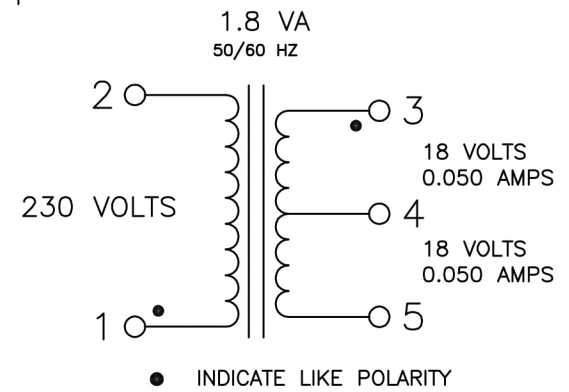
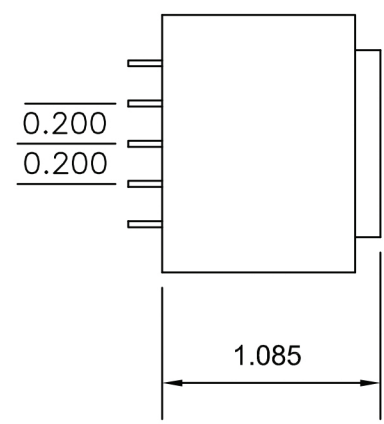
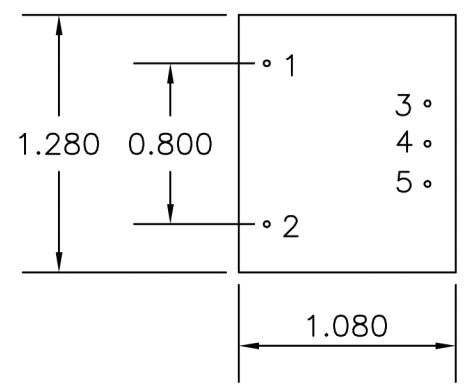
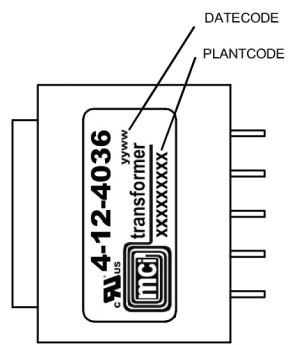
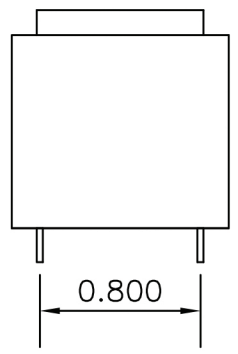

## NOTES:

- 1) UL RECOGNIZED COMPONENT: FILE # E86403
- 2) 3750 VRMS HIPOT BETWEEN PRIMARY AND SECONDARY.
- 3) WEIGHT: 0.21 LBS.
- 4) RoHS AND REACH COMPLIANT
- 5) ALL DIMENSIONS ARE IN INCHES.

<b>MCI</b>				<i>NORTH BABYLON N.Y.</i>
CUSTOMER MCI				
TITLE HORIZONTAL PC TRANSFORMER				
DRAWN BY JOW3	APPRVD BY JOW	SCALE NONE	DATE 11-29-16	DRAWING NUMBER 4-12-4036