

REVISIONS

LETTER	DESCRIPTION	DWG BY	DATE

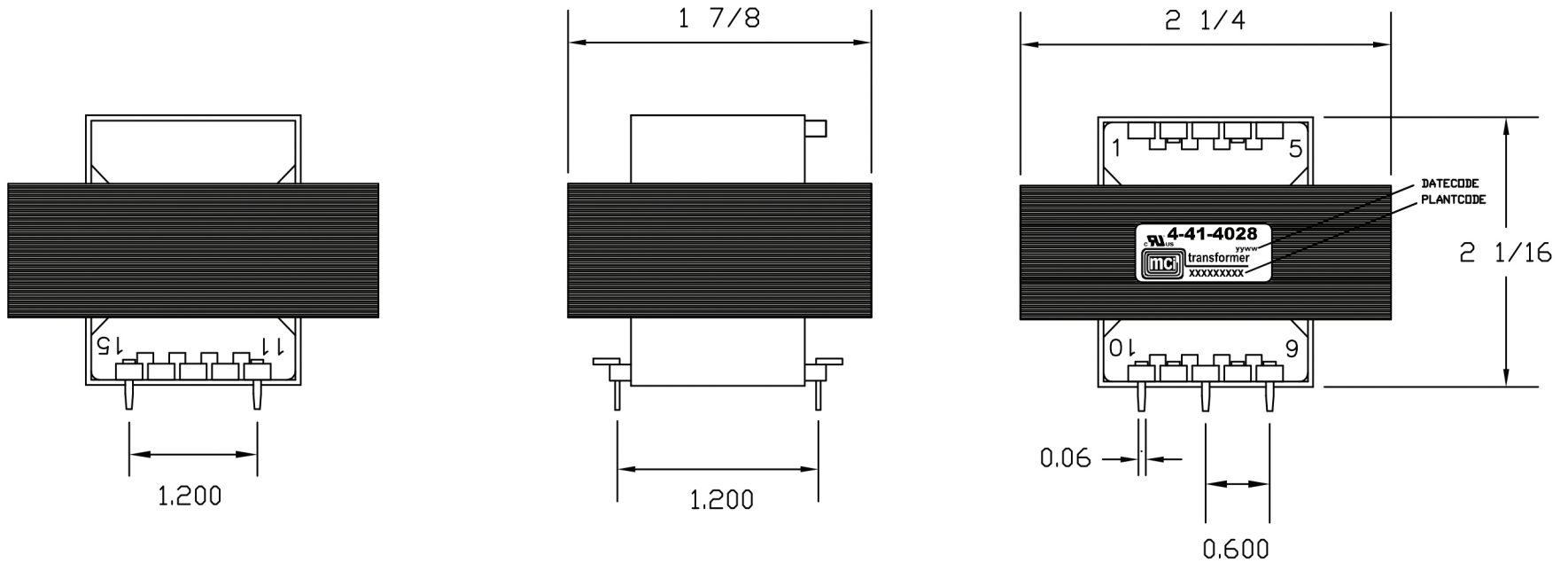

NOTES:

- 1) UL RECOGNIZED COMPONENT: STANDARD XPTQ2, FILE E86403
- 2) UL CERTIFIED FOR CANADA-COMPONENT: STANDARD XPTQ8, FILE E86403
- 3) WEIGHT: 1.20 LBS.
- 4) RoHS AND REACH COMPLIANT
- 5) ALL DIMENSIONS ARE IN INCHES.
- 6) 4000 VOLT HIPOT BETWEEN PRIMARY AND (SECONDARY AND CORE)
500 VOLT HIPOT FROM SECONDARY TO CORE.

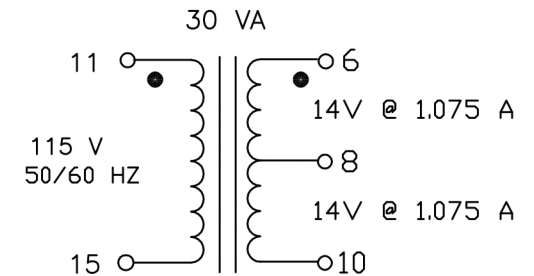

● LIKE POLARITIES

MCI		<i>NORTH BABYLON N.Y.</i>	
CUSTOMER		MCI	
TITLE VDE HORIZONTAL P.C. TRANSFORMER			
DRAWN BY	APPRVD BY	SCALE	DATE
JOW3	JOW	NONE	1-10-17
DRAWING NUMBER			4-41-4028