

# REVISIONS

LETTER	DESCRIPTION	DWG BY	DATE

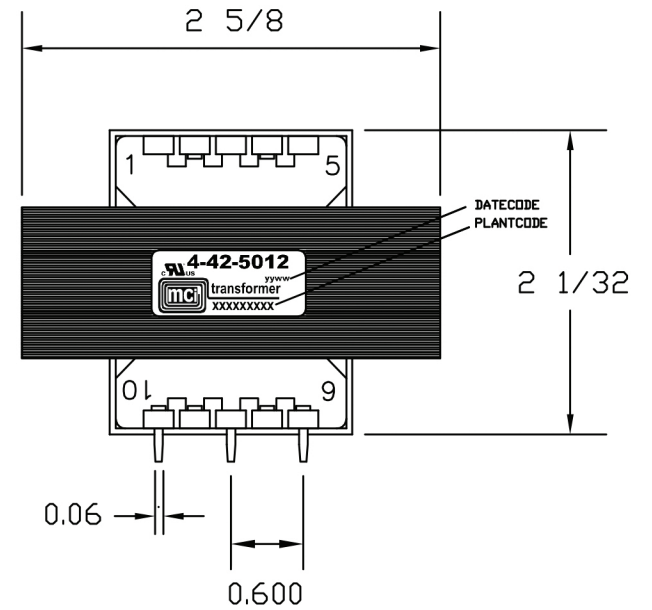
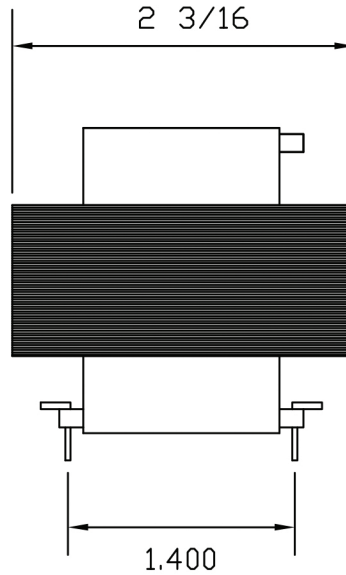
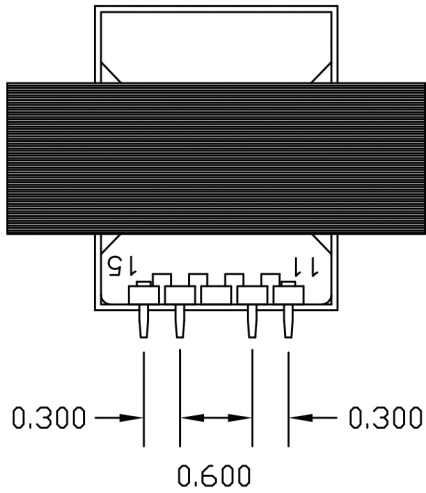

## NOTES:

- 1) UL RECOGNIZED COMPONENT: STANDARD XPTQ2, FILE E86403
- 2) UL CERTIFIED FOR CANADA-COMPONENT: STANDARD XPTQ8, FILE E86403
- 3) WEIGHT: 1.40 LBS.
- 4) RoHS AND REACH COMPLIANT
- 5) ALL DIMENSIONS ARE IN INCHES.
- 6) 4000 VOLT HIPOT BETWEEN PRIMARY AND (SECONDARY AND CORE)  
500 VOLT HIPOT FROM SECONDARY TO CORE.

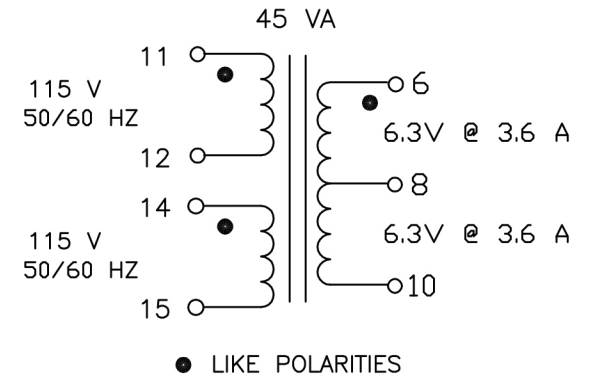

<b>MCI</b>		<small>NORTH BABYLON N.Y.</small>	
CUSTOMER		MCI	
TITLE VDE HORIZONTAL P.C. TRANSFORMER			
DRAWN BY	APPRVD BY	SCALE	DATE
JOW3	JOW	NONE	1-18-17
DRAWING NUMBER			4-42-5012