

REVISIONS

LETTER	DESCRIPTION	DATE

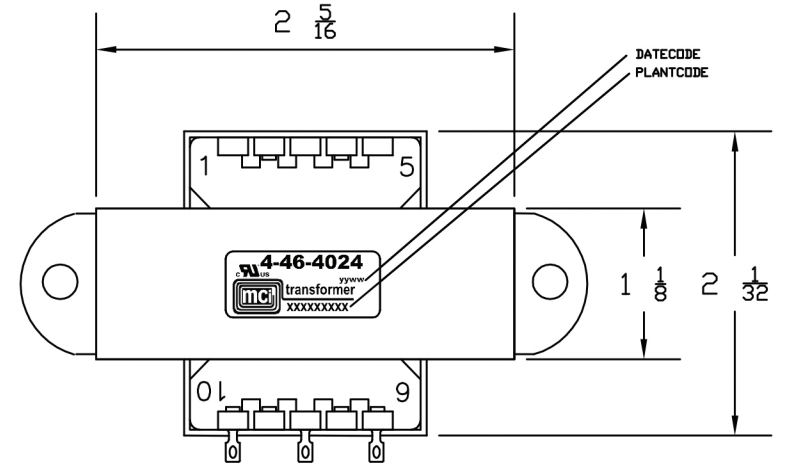
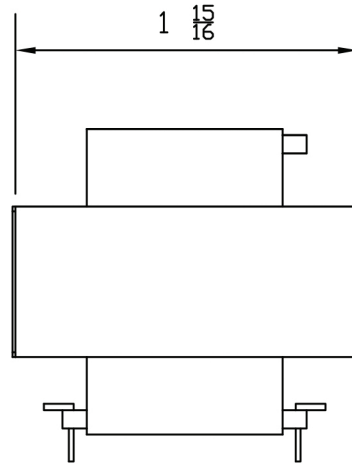
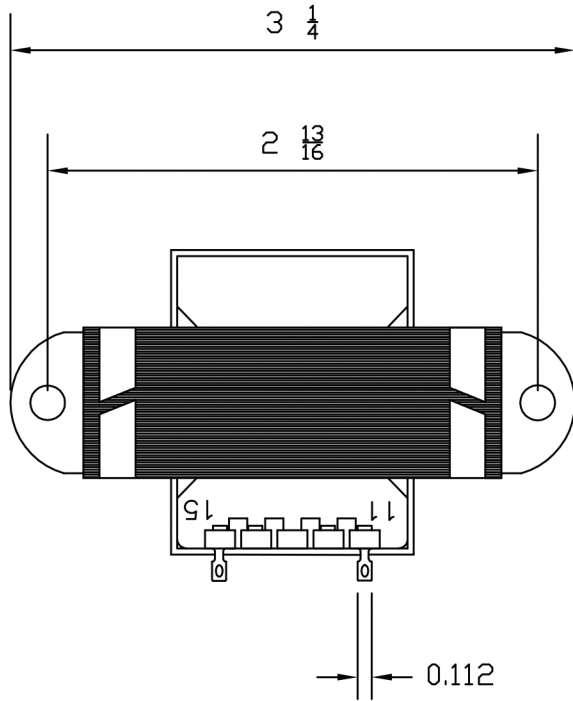

NOTES:

- 1) UL RECOGNIZED COMPONENT: STANDARD XPTQ2, FILE E86403
- 2) UL CERTIFIED FOR CANADA-COMPONENT: STANDARD XPTQ8, FILE E86403
- 3) WEIGHT: 1.20 LBS.
- 4) RoHS AND REACH COMPLIANT
- 5) ALL DIMENSIONS ARE IN INCHES
- 6) 4000 VOLT HIPOT BETWEEN PRIMARY AND (SECONDARY AND CORE)
500 VOLT HIPOT FROM SECONDARY TO CORE

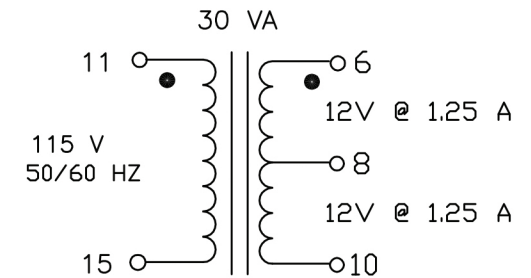

● LIKE POLARITIES

MCI		<i>NORTH BABYLON N.Y.</i>	
CUSTOMER		MCI	
TITLE VDE QUICK CONNECT TRANSFORMER			
DRAWN BY	APPRVD BY	SCALE	DATE
JOW3	JOW	NONE	1-11-17
DRAWING NUMBER			4-46-4024