

REVISIONS

LETTER	DESCRIPTION	DATE

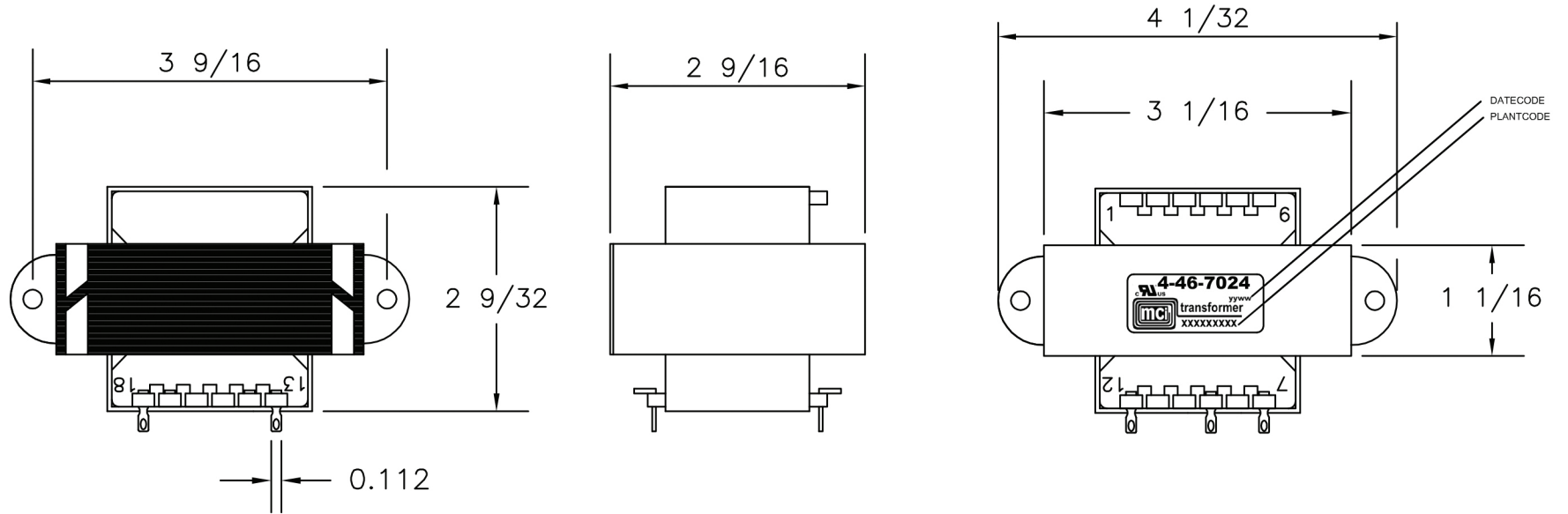

NOTES:

- 1) UL RECOGNIZED COMPONENT: STANDARD XPTQ2, FILE E86403
- 2) UL CERTIFIED FOR CANADA-COMPONENT: STANDARD XPTQ8, FILE E86403
- 3) WEIGHT: 2.4 LBS.
- 4) RoHS AND REACH COMPLIANT
- 5) ALL DIMENSIONS ARE IN INCHES
- 6) 4000 VOLT HIPOT BETWEEN PRIMARY AND (SECONDARY AND CORE)
500 VOLT HIPOT FROM SECONDARY TO CORE

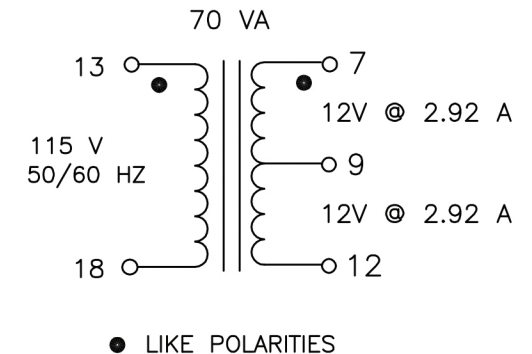

MCI					NORTH BABYLON N.Y.
CUSTOMER		MCI			
TITLE VDE QUICK CONNECT TRANSFORMER					
DRAWN BY	APPRVD BY	SCALE	DATE	DRAWING NUMBER	
JOW3	JOW	NONE	1-17-17	4-46-7024	