

REVISIONS

LETTER	DESCRIPTION	DATE

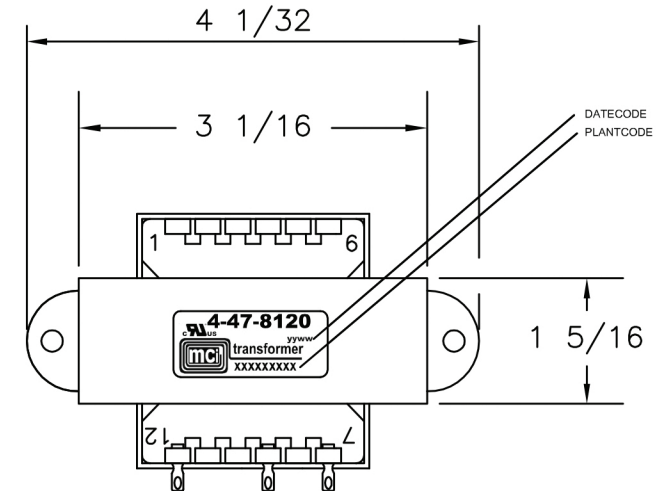
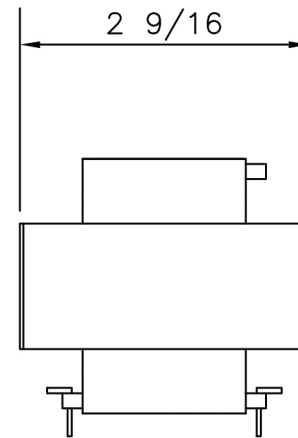
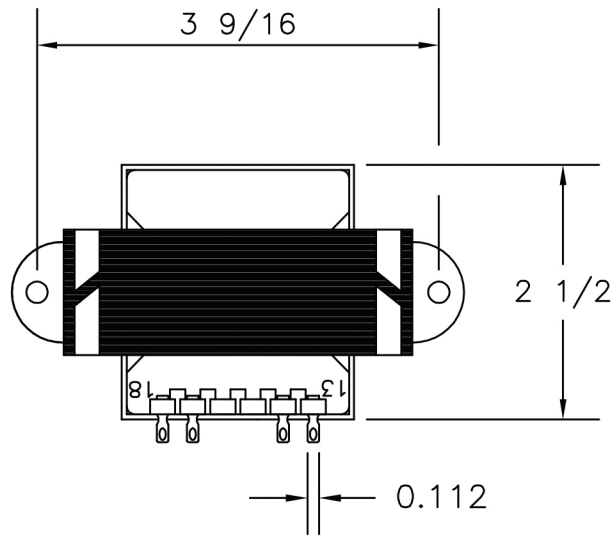

NOTES:

- 1) UL RECOGNIZED COMPONENT: STANDARD XPTQ2, FILE E86403
- 2) UL CERTIFIED FOR CANADA-COMPONENT: STANDARD XPTQ8, FILE E86403
- 3) WEIGHT: 2.8 LBS.
- 4) RoHS AND REACH COMPLIANT
- 5) ALL DIMENSIONS ARE IN INCHES
- 6) 4000 VOLT HIPOT BETWEEN PRIMARY AND (SECONDARY AND CORE)
2000 VOLT HIPOT FROM SECONDARY TO CORE

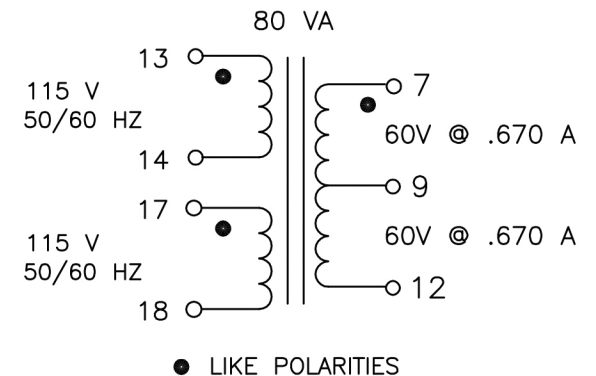

MCI					NORTH BABYLON N.Y.
CUSTOMER		MCI			
TITLE VDE QUICK CONNECT TRANSFORMER					
DRAWN BY	APPRVD BY	SCALE	DATE	DRAWING NUMBER	
SMS	JOW	NONE	1-17-17	4-47-8120	