

REVISIONS

LETTER	DESCRIPTION	DATE

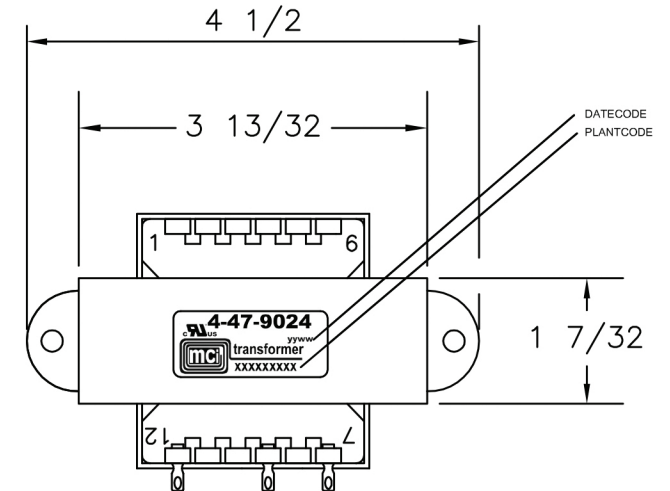
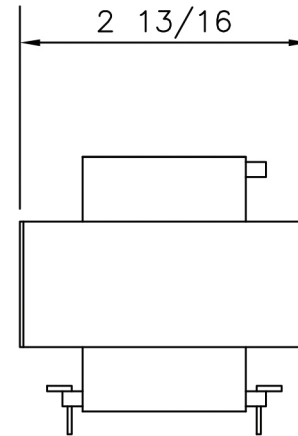
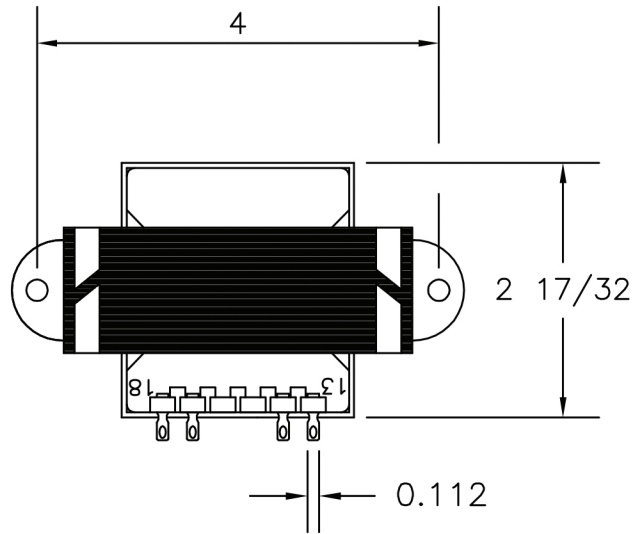

NOTES:

- 1) UL RECOGNIZED COMPONENT: STANDARD XPTQ2, FILE E86403
- 2) UL CERTIFIED FOR CANADA-COMPONENT: STANDARD XPTQ8, FILE E86403
- 3) WEIGHT: 3.2 LBS.
- 4) RoHS AND REACH COMPLIANT
- 5) ALL DIMENSIONS ARE IN INCHES
- 6) 4000 VOLT HIPOT BETWEEN PRIMARY AND (SECONDARY AND CORE)
500 VOLT HIPOT FROM SECONDARY TO CORE

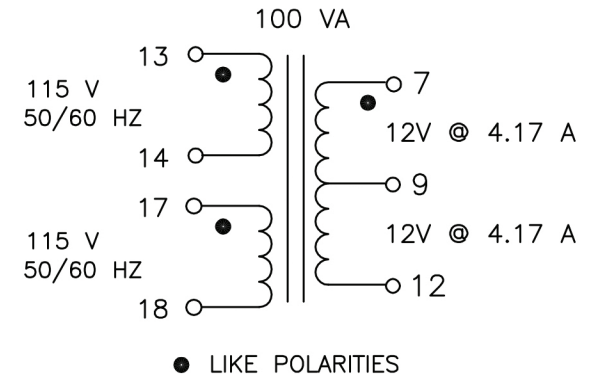

MCI					<i>NORTH BABYLON N.Y.</i>
CUSTOMER		MCI			
TITLE VDE QUICK CONNECT TRANSFORMER					
DRAWN BY	APPRVD BY	SCALE	DATE	DRAWING NUMBER	
SMS	JOW	NONE	1-17-17	4-47-9024	