

REVISIONS

LETTER	DESCRIPTION	DATE

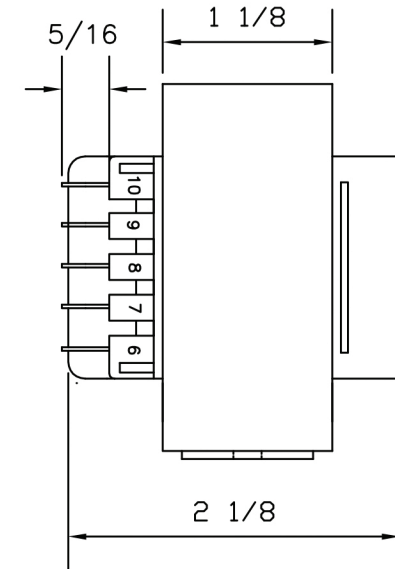
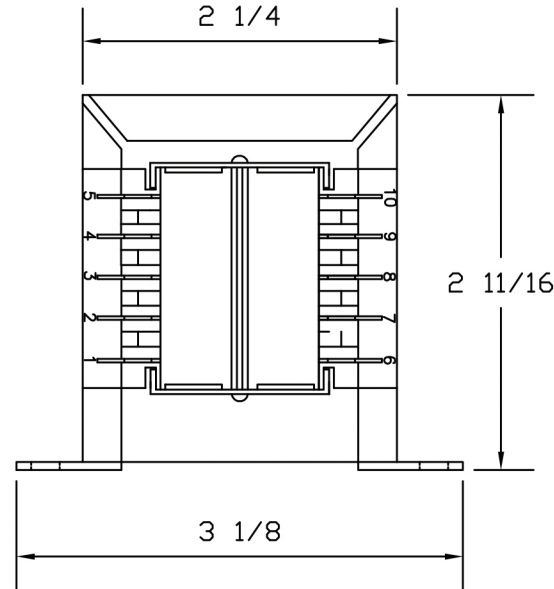
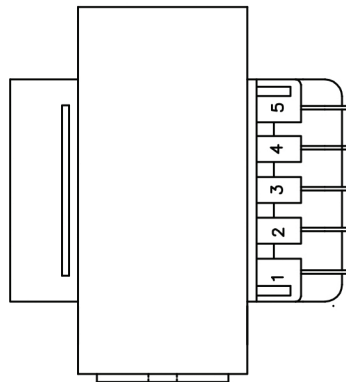
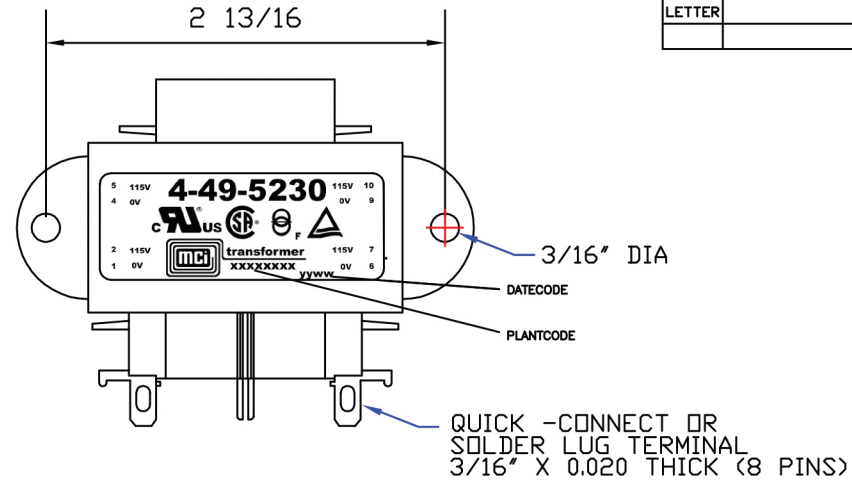
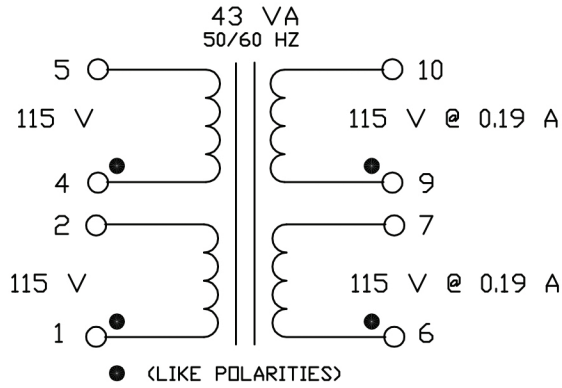

NOTES:

- 1) UL INSULATION SYSTEM E86543—CLASS F 155°C.
- 2) UL RECOGNIZED COMPONENT: FILE # E86403
- 3) ISOLATION TRANSFORMER CONSTRUCTION UL 60601-1 AND CSA C22.2 NO. 601.1-M90: FILE #E178395
- 4) TUV CERTIFIED: EN61558-1 AND EN61558-2-4, "IPPOO: FAIL-SAFE SAFETY ISOLATION TRANSFORMER Ⓢ"
- 5) CSA CERTIFIED: FILE # LR80864
- 6) 4000 VRMS HIPOT BETWEEN PRIMARY AND (SECONDARY + CORE).
500 VOLTS BETWEEN SECONDARY AND CORE.
- 7) WEIGHT: 1.6 LBS.
- 8) RoHS AND REACH COMPLIANT
- 9) ALL DIMENSIONS ARE IN INCHES.

MCI				<small>NORTH BABYLON N.Y.</small>
CUSTOMER		MCI		
TITLE VDE QUICK CONNECT TRANSFORMER				
DRAWN BY	APPRVD BY	SCALE	DATE	DRAWING NUMBER
JOW3	JOW		2-8-17	4-49-5230