

REVISIONS

LETTER	DESCRIPTION	DATE
A	REDRAWN AND UPDATED NOTES	2-13-17

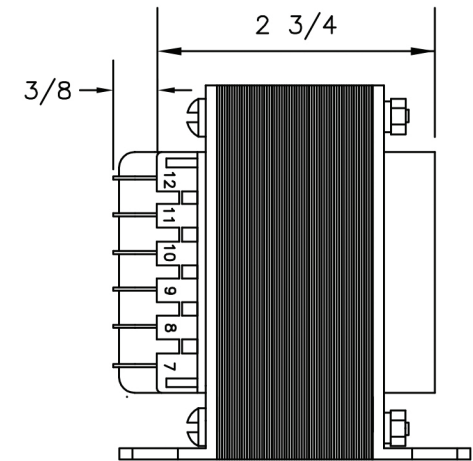
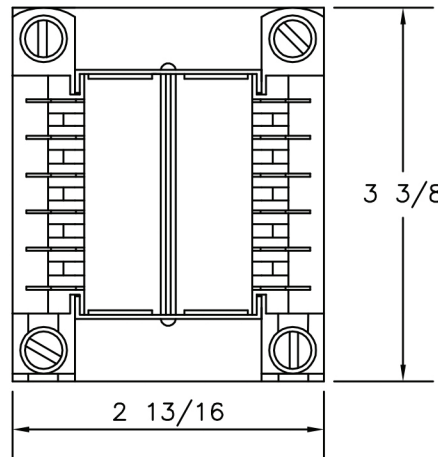
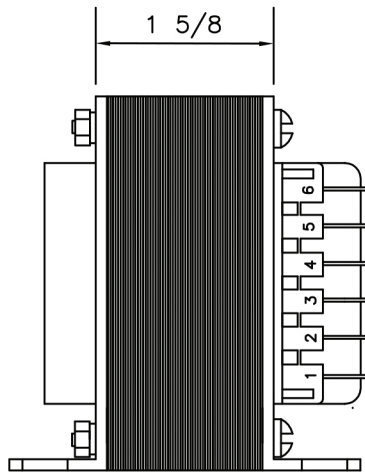
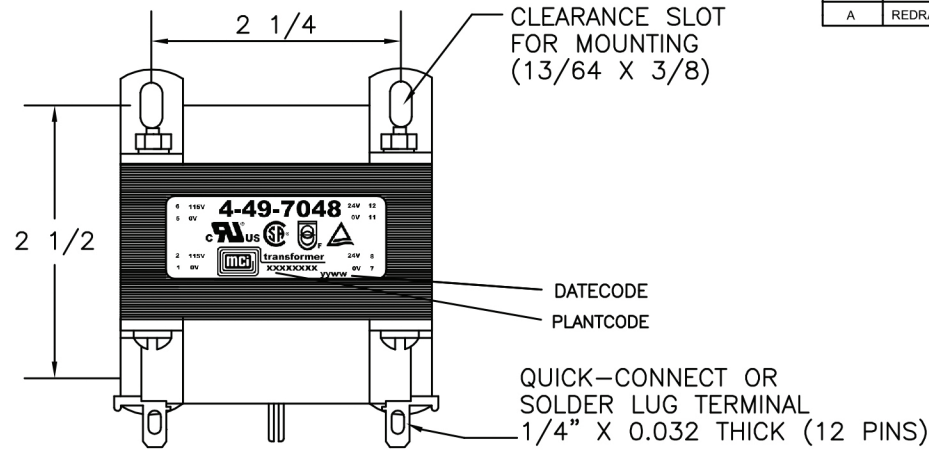
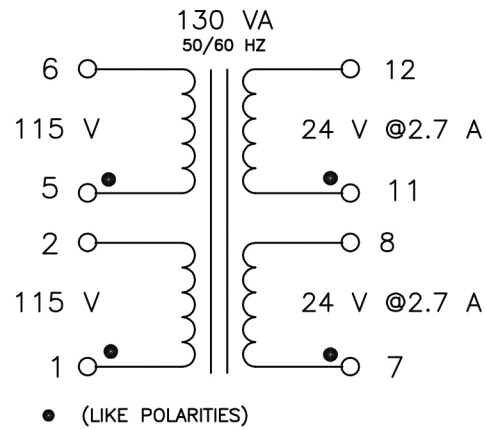

NOTES:

- 1) UL INSULATION SYSTEM E86543-CLASS F 155°C.
- 2) UL RECOGNIZED COMPONENT: FILE # E86403
- 3) ISOLATION TRANSFORMER CONSTRUCTION UL 60601-1 AND CSA C22.2 NO. 601.1-M90: FILE #E178395
- 4) TUV CERTIFIED: EN61558-1 AND EN61558-2-6, "IPOO: FAIL-SAFE SAFETY ISOLATION TRANSFORMER"
- 5) CSA CERTIFIED: FILE # LR80864
- 6) 4000 VRMS HIPOT BETWEEN PRIMARY AND (SECONDARY + CORE).
500 VOLTS BETWEEN SECONDARY AND CORE.
- 7) WEIGHT: 4.1 LBS.
- 8) RoHS AND REACH COMPLIANT
- 9) ALL DIMENSIONS ARE IN INCHES.

MCI					<i>NORTH BABYLON N.Y.</i>
CUSTOMER		MCI			
TITLE		VDE QUICK CONNECT TRANSFORMER			
DRAWN BY	APPRVD BY	SCALE	DATE	DRAWING NUMBER	
SMS	JOW	NONE	7-29-16	4-49-7048	