

# REVISIONS

LETTER	DESCRIPTION	DWG BY	DATE
A	UPDATED LABEL	JOW3	8-2-17

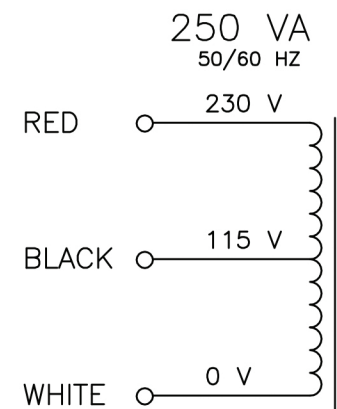
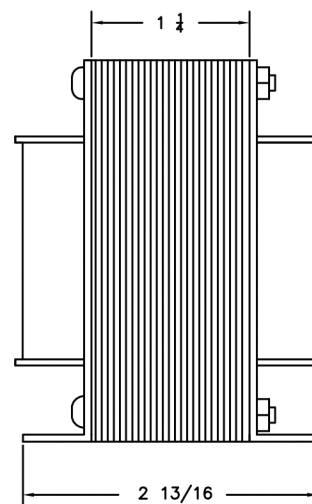
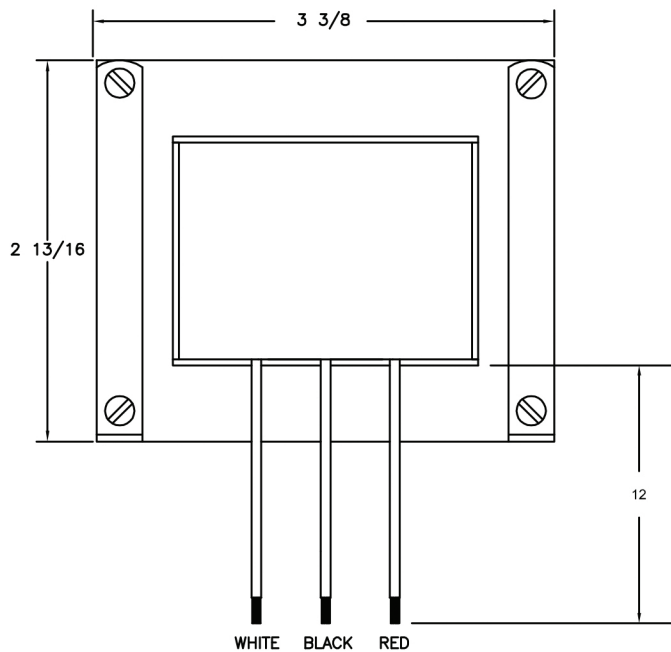
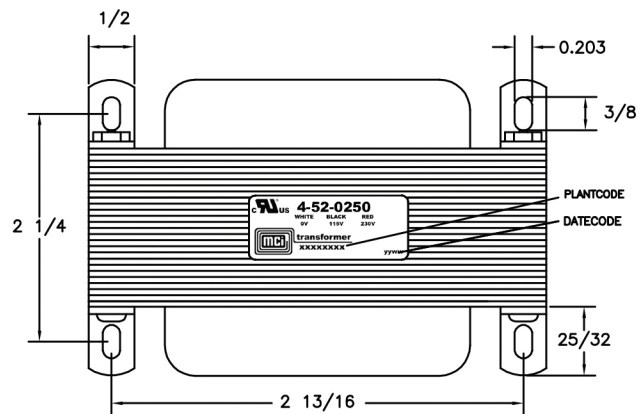

## NOTES:

- 1) UL INSULATION SYSTEM E86543-CLASS F 155°C.
- 2) UL RECOGNIZED COMPONENT: ANSI/UL506, ANSI/UL5085-1 AND ANSI/UL5085-2: FILE # E86403.
- 3) LEAD WIRES: 18 AWG, 12" LONG.
- 4) 2500 VRMS HIPOT BETWEEN COIL AND CORE.
- 5) WEIGHT: 3.7 LBS.
- 6) RoHS AND REACH COMPLIANT.
- 7) ALL DIMENSIONS ARE IN INCHES.

<b>MCI</b>				
<i>NORTH BABYLON N.Y.</i>				
CUSTOMER		MCI		
TITLE				
115/230V AUTOTRANSFORMER 250 VA				
DRAWN BY	APPRVD BY	SCALE	DATE	DRAWING NUMBER
SMS	JOW	NONE	2-28-17	4-52-0250