

# REVISIONS

LETTER	DESCRIPTION	DWG BY	DATE
A	REDRAWN AND UPDATED NOTES	JOW3	11-11-16
B	UPDATED NOTES	JOW3	2-6-17
C	UPDATED LABEL	JOW3	6-22-17

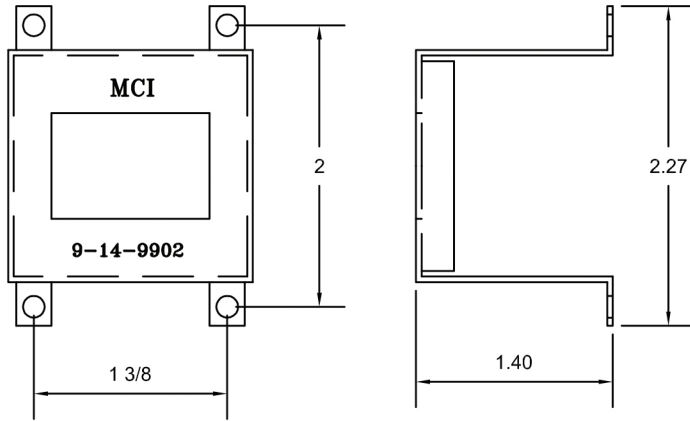

OPTIONAL MOUNTING BRACKET: PART #9-14-9902

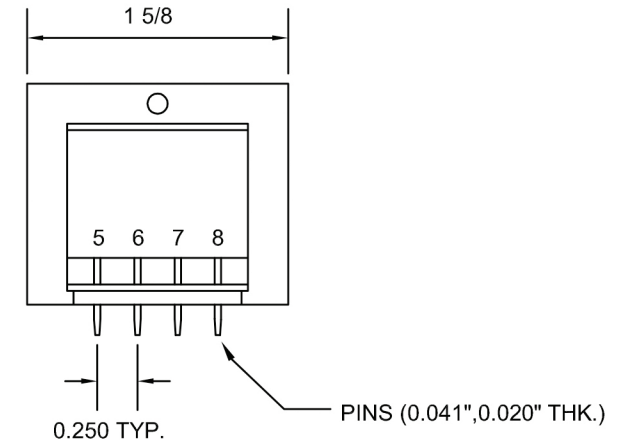
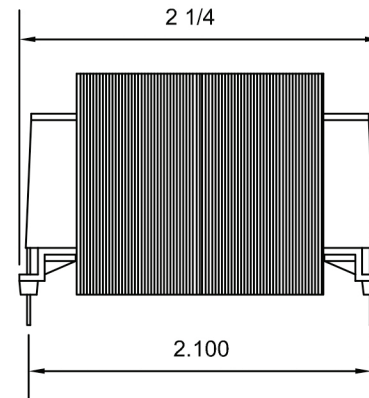
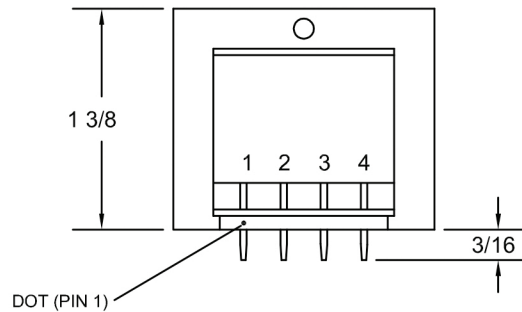
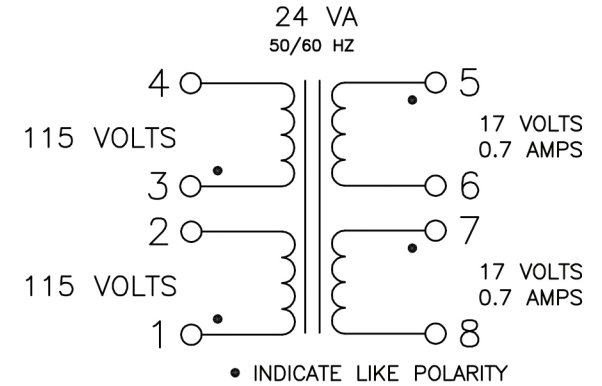
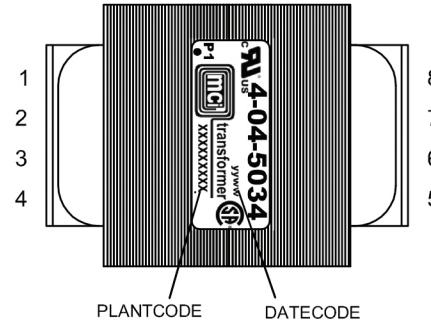

## NOTES:

- 1) UL RECOGNIZED COMPONENT: FILE # E86403
- 2) CSA CERTIFIED COMPONENT: FILE # LR80864
- 3) 1500 VRMS HIPOT BETWEEN PRIMARY AND (SECONDARY + CORE).  
500 VOLTS BETWEEN SECONDARY AND CORE.
- 4) WEIGHT: 0.75 LBS
- 5) RoHS AND REACH COMPLIANT
- 6) ALL DIMENSIONS ARE IN INCHES.

<b>MCI</b>					<small>NORTH BABYLON N.Y.</small>
CUSTOMER		MCI			
TITLE		VERTICAL PC TRANSFORMER			
DRAWN BY	APPRVD BY	SCALE	DATE	DRAWING NUMBER	
SMS	JOW	NONE	10-10-14	4-04-5034	